

# Chapter 14

---

## Hybrid Control

# Motivation

---

In this chapter we will study *Hybrid Control*. By this terminology we mean the combination of a *digital* control law with a *continuous-time* system. We will be particularly interested in how the continuous response differs from that seen at the sampling points.

We recall the motivational example presented in the slides for Chapter 12.

These are repeated below for completeness.

# D.C. Servo Motor Control

---

We consider the control of a d.c. servo system via a computer. This is a very simple example. Yet we will show that this simple example can (when it is fully understood) actually illustrate almost an entire course on control.

A photo of a typical d.c. servo system is shown on the next slide.

# Photo of Servo Laboratory System with Digital Control via a PC

---

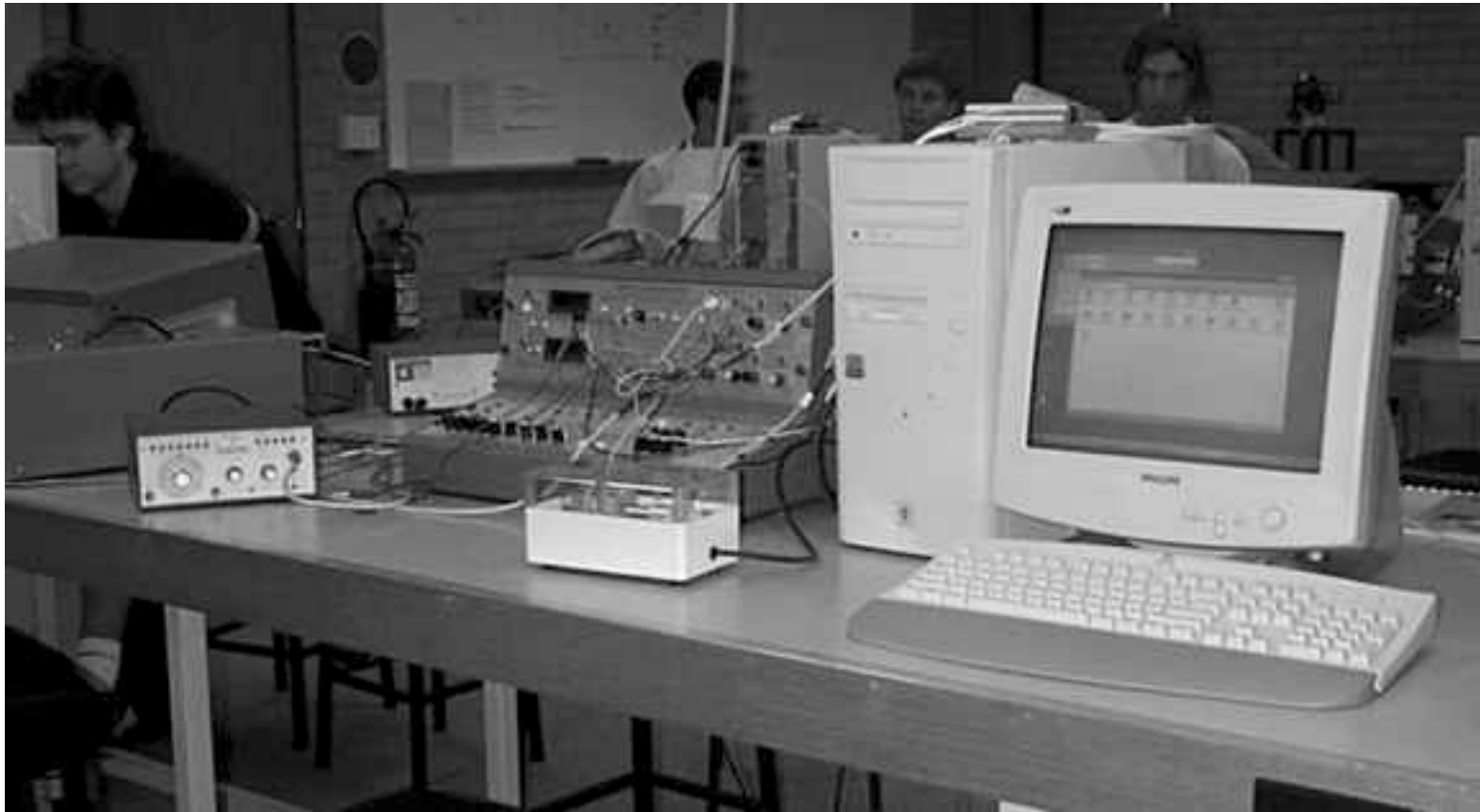

---

The set-up for digital control of this system is shown schematically below:

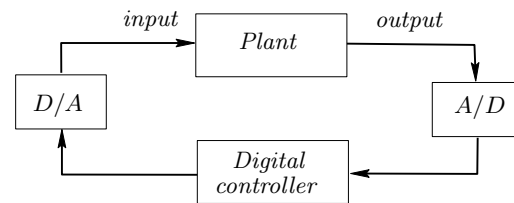

The objective is to cause the output shaft position,  $y(t)$ , to follow a given reference signal,  $y^*(t)$ .

# Modelling

---

Since the control computations will be done inside the computer, it seems reasonable to first find a model relating the sampled output,  $\{y(k\Delta); k = 0, 1, \dots\}$  to the sampled input signals generated by the computer, which we denote by  $\{u(k\Delta), k = 0, 1, \dots\}$ . (Here  $\Delta$  is the sample period).

---

We saw in Chapter 12 that the output at time  $k\Delta$  can be modelled as a linear function of past outputs and past controls.

Thus the (*discrete time*) model for the servo takes the form:

$$y(\overline{k+1}\Delta) = \bar{a}_1 y(k\Delta) + \bar{a}_0 y(\overline{k-1}\Delta) + \bar{b}_1 u(k\Delta) + \bar{b}_0 u(\overline{k-1}\Delta).$$

# A Prototype Control Law

---

Conceptually, we want  $y(\overline{k+1}\Delta)$  to go to the desired value  $y^*$ . This suggests that we could simply set the right hand side of the equation on the previous slide equal to  $y^*$ . Doing this we see that  $u(k\Delta)$  becomes a function of  $y(k\Delta)$  (as well as  $y(\overline{k-1}\Delta)$  and  $u(\overline{k-1}\Delta)$ ). At first glance this looks reasonable but on reflection we have left no time to make the necessary calculations. Thus, it would be better if we could reorganize the control law so that  $u(k\Delta)$  becomes a function of  $y(\overline{k-1}\Delta)$ , ... . Actually this can be achieved by changing the model slightly as we show on the next slide.



# Model Development

---

Substituting the model into itself to yield:

$$\begin{aligned}
 y(\overline{k+1}\Delta) &= \bar{a}_1 \{y(k\Delta)\} + \bar{a}_0 y(\overline{k-1}\Delta) \\
 &\quad + \bar{b}_1 u(k\Delta) + \bar{b}_0 u(\overline{k-1}\Delta) \\
 &= \bar{a}_1 \{ \bar{a}_1 y(\overline{k-1}\Delta) + \bar{a}_0 y(\overline{k-2}\Delta) \\
 &\quad + \bar{b}_1 u(\overline{k-1}\Delta) + \bar{b}_0 u(\overline{k-2}\Delta) \} \\
 &\quad + \bar{a}_0 y(\overline{k-1}\Delta) + \bar{b}_1 u(k\Delta) + \bar{b}_0 u(\overline{k-1}\Delta)
 \end{aligned}$$

---

We see that  $y(\overline{k+1}\Delta)$  takes the following form:

$$y(\overline{k+1}\Delta) = \alpha_1 y(\overline{k-1}\Delta) + \alpha_2 y(\overline{k-2}\Delta) \\ + \beta_1 u(\overline{k}\Delta) + \beta_2 u(\overline{k-1}\Delta) + \beta_3 u(\overline{k-2}\Delta)$$

where  $\alpha_1 = \bar{a}_1^2 + \bar{a}_0$  etc.

---

Actually,  $\alpha_1, \alpha_2, \beta_1, \beta_2, \beta_3$ , can be estimated from the physical system. We will not go in to details here. However, for the system shown earlier the values turn out to be as follows for  $\Delta = 0.05$  seconds:

$$\alpha_1 = 0.03554$$

$$\alpha_2 = 0.03077$$

$$\beta_1 = 1$$

$$\beta_2 = -1.648$$

$$\beta_3 = 0.6483$$

# A Modified Prototype Control Law

---

Now we want the output to go to the reference  $y^*$ .

Recall we have the model:

$$y(\bar{k} + 1\Delta) = \alpha_1 y(\bar{k} - 1\Delta) + \alpha_2 y(\bar{k} - 2\Delta) \\ + \beta_1 u(\bar{k}\Delta) + \beta_2 u(\bar{k} - 1\Delta) + \beta_3 u(\bar{k} - 2\Delta)$$

This suggests that all we need do is set  $y(\bar{k} + 1\Delta)$  equal to the desired set-point  $y^*(\bar{k} + 1\Delta)$  and solve for  $u(k\Delta)$ .  
The answer is

---

---

$$u(k\Delta) = \frac{y^*(\overline{k+1}\Delta) - \alpha_1 y(\overline{k-1}\Delta) - \alpha_2 y(\overline{k-2}\Delta) - \beta_2 u(\overline{k-1}\Delta) - \beta_3 u(\overline{k-2}\Delta)}{\beta_1}$$

Notice that the above control law expresses the current control  $u(k\Delta)$  as a function of

- ◆ the reference,  $y^*(\overline{k+1}\Delta)$
- ◆ past output measurements,  $y(\overline{k-1}\Delta)$ ,  $y(\overline{k-2}\Delta)$
- ◆ past control signals,  $u(\overline{k-1}\Delta)$ ,  $u(\overline{k-2}\Delta)$

---

Also notice that 1 sampling interval exists between the measurement of  $y(\overline{k-1}\Delta)$  and the time needed to apply  $u(k\Delta)$ ; i.e. we have specifically allowed time for the computation of  $u(k\Delta)$  to be performed after  $y(\overline{k+1}\Delta)$  is measured!

# Recap

---

All of this is very plausible so far. We have obtained a simple *digital* control law which causes  $y(\overline{k+1}\Delta)$  to go to the desired value  $y^*(\overline{k+1}\Delta)$  in one step !

Of course, the real system evolves in continuous time (*readers may care to note this point for later consideration*).

# Simulation Results

---

To check the above idea, we run a computer simulation. The results are shown on the next slide. Here the reference is a square wave. Notice that, as predicted, the output follows the reference with a delay of just 2 samples.



# Simulation Results with Sampling Period 0.05 seconds

---

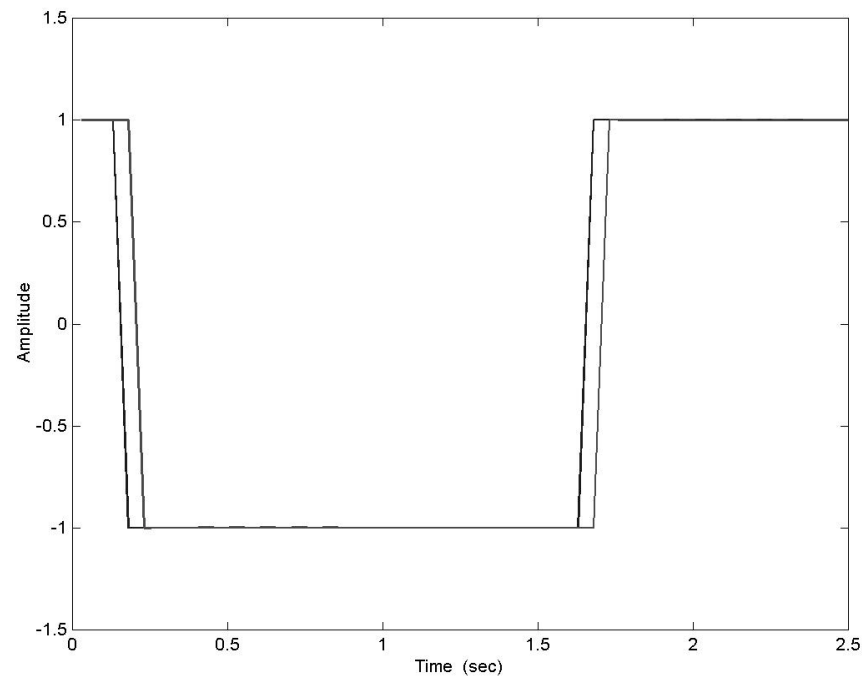

# Intersample Issues

---

However, we recall from Chapter 12, that if we look at the output response at a rate faster than the control sampling rate then we see that the actual response is as shown on the next slide.

# Simulation result showing full continuous output response

---

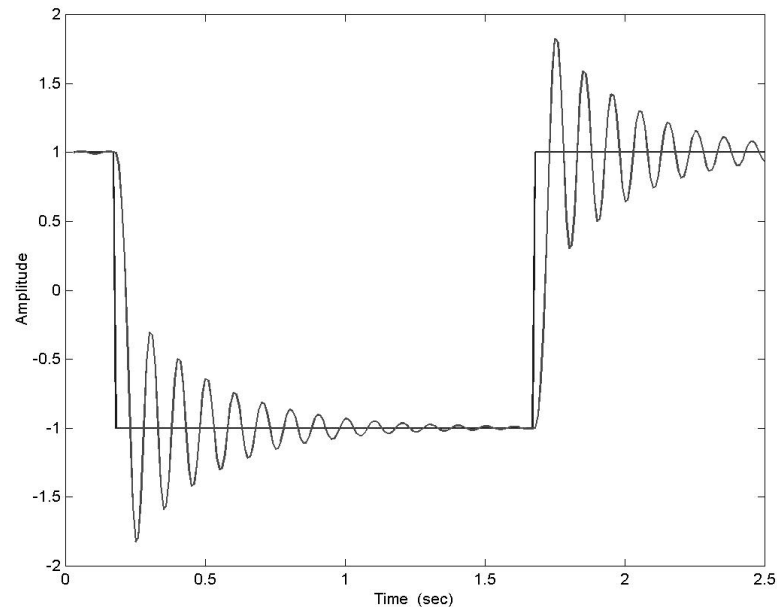

---

This result was rather surprising when we saw it for the first time in Chapter 12. However, we argued earlier that we only asked that the sampled output go to the desired reference. Indeed it has. However, we said nothing about the intersample response!

As promised in chapters 12 and 13, a full explanation of this phenomenon will be given in the current chapter.

---

We saw in the example above (*and several others described in Chapter 13*), that the continuous response could contain nasty surprises if certain digital controllers were implemented on continuous systems. The purpose of this chapter is to analyze this situation and to explain:

- ❖ why the continuous response can appear very different from that predicted by the at-sample response
- ❖ how to avoid these difficulties in digital control.

# Models for Hybrid Control Systems

---

A hybrid control loop containing both continuous and discrete time elements is shown in Figure 14.1.

We denote the discrete equivalent transfer function of the combination {zero order hold + Continuous Plant + Filter} as  $[FG_0G_{h0}]_q$ . We have

$$[FG_0G_{h0}]_q = \mathcal{Z} \{ \text{sampled impulse response of } F(s)G_o(s)G_{h0}(s) \}$$

Figure 14.1: *Sampled data control loop. Block form*

---

---

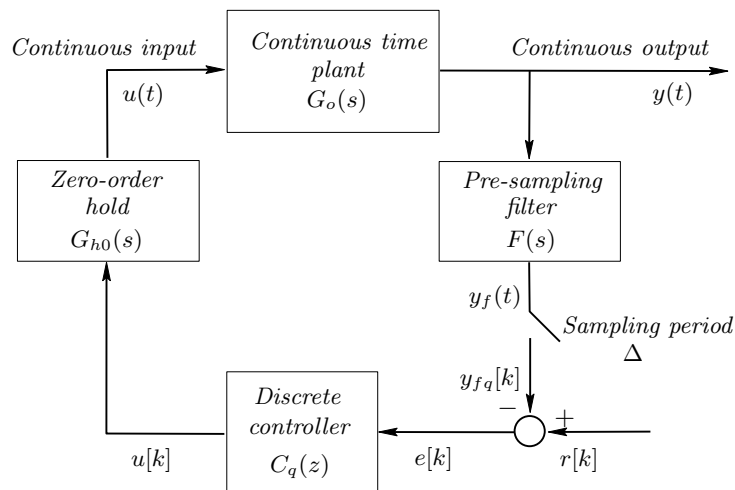

# Model Development

---

We associate a fictitious staircase function,  $\hat{y}_f(t)$  with the sequence  $\{y_f[k]\}$  where

$$\hat{y}_f(t) = \sum_{k=0}^{\infty} y_f[k] (\mu(t - k\Delta) - \mu(t - (k + 1)\Delta))$$

where  $\mu(t - \tau)$  is a unit step function starting at  $\tau$  - *see next slide* . We also note that, due to the zero order hold,  $u(t)$  is already a staircase function, i.e.

$$u(t) = \hat{u}(t) = \sum_{k=0}^{\infty} u[k] (\mu(t - k\Delta) - \mu(t - (k + 1)\Delta))$$



Figure 14.2: *Connections between  $y_f(t)$ ,  $y_f[k]$  and  $\hat{y}_f(t)$  for  $y_f(t) = \sin(2\pi t)$ ,  $\Delta=0.1$*

---

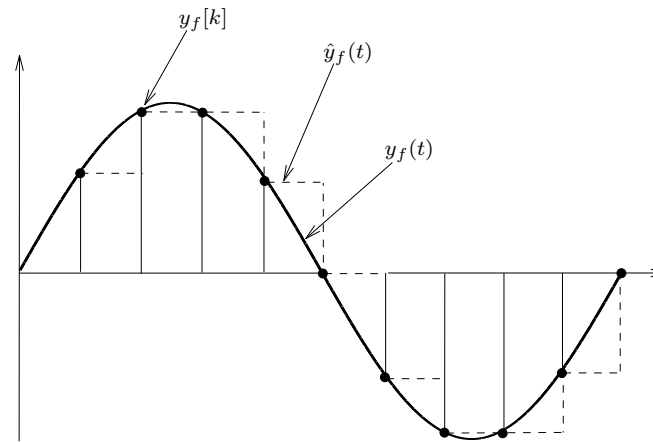

---

The Laplace Transform of  $\hat{u}(t)$  can be related to the Z-transform of  $\{u[k]\}$  as follows:

$$\begin{aligned}\hat{U}(s) = \mathcal{L}\{\hat{u}(t)\} &= \int_0^{\infty} e^{-st} \hat{u}(t) dt \\ &= \int_0^{\infty} e^{-st} \sum_{k=0}^{\infty} u[k] (\mu(t - k\Delta) - \mu(t - (k+1)\Delta)) dt\end{aligned}$$

---

---

Interchanging the order of summation and integration, we have

$$\begin{aligned} U(s) = \hat{U}(s) &= \sum_{k=0}^{\infty} u[k] \left( \frac{e^{-k\Delta s} - e^{-(k+1)\Delta s}}{s} \right) \\ &= \sum_{k=0}^{\infty} u[k] e^{-k\Delta s} \left[ \frac{1 - e^{-\Delta s}}{s} \right] \\ &= U_q(e^{\Delta s}) G_{ho}(s) \end{aligned}$$

where  $U_q(s)$  is the Z-transform of  $\{u[k]\}$ .

---

We know from standard discrete analysis (*see Chapter 13*) that  $Y_{fq}(z)$  is related to  $U_q(z)$  and the sampled reference input  $R_q(z)$  via standard discrete transfer functions, i.e.

$$U_q(z) = C_q(z) [R_q(z) - Y_{fq}(z)]$$

Multiplying both sides by  $G_{ho}(s)$  and setting  $z=e^{s\Delta}$  gives

$$\begin{aligned} [G_{ho}(s)U_q(e^{s\Delta})] &= -C_q(e^{s\Delta})G_{ho}(s)Y_{fq}(e^{s\Delta}) \\ &\quad + C(e^{s\Delta})G_{ho}(s)R_q(e^{s\Delta}) \end{aligned}$$

---

Using the earlier expressions for  $\hat{U}(s)$  we obtain

$$\hat{U}(s) = -C_q(e^{s\Delta})\hat{Y}_f(s) + C_q(e^{s\Delta})G_{ho}(s)R_q(e^{s\Delta})$$

Similarly we can see that

$$\hat{Y}_f(s) = [FG_oG_{h0}]_q(e^{s\Delta})\hat{U}(s)$$

Hence for analysis purposes, we can redraw the loop in Figure 14.1 as on the next slide.

Figure 14.3: *Transfer function form of a sampled data control loop*

---

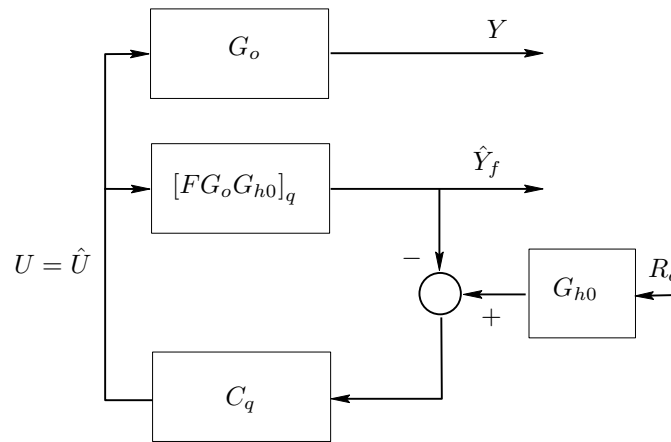

---

From the previous slide, we see that the Laplace transform of the continuous output of the hybrid loop is given by

$$Y(s) = \left[ \frac{C_q(e^{s\Delta})G_o(s)G_{h0}(s)}{1 + C_q(e^{s\Delta})[FG_oG_{h0}]_q(e^{s\Delta})} \right] R_q(e^{s\Delta})$$

---

Note that, even when the reference input is a pure sinusoid, the continuous time output will not, in general, be sinusoidal. This is because  $R_q(e^{j\omega_0})$  is a periodic function and hence it follows that  $Y(j\omega)$  will have components at  $\{\omega = \omega_0 + \frac{2k\pi}{\Delta}; k = \dots, -1, 0, 1, \dots\}$ .

We next use the above insights to analyze the continuous output response resulting from the hybrid control loop.



# Analysis of Intersample Behavior

---

The starting point for analyzing intersample behavior is the set of results given above for the continuous time output of a hybrid loop. In particular, recall that

$$Y_f(s) = \frac{C_q(e^{s\Delta})F(s)G_o(s)G_{h0}(s)}{1 + C_q(e^{s\Delta})[FG_oG_{h0}]_q(e^{s\Delta})}R_q(e^{s\Delta})$$

---

Also, we recall that the sampled output response is given by

$$Y_{fq}(e^{s\Delta}) = T_{oq}(e^{s\Delta})R_q(e^{s\Delta})$$

where  $T_{oq}(z)$  is the shift domain complementary sensitivity, i.e.

$$T_{oq}(z) = \frac{Y_{fq}(z)}{R_q(z)} = \frac{C_q(z) [FG_oG_{h0}]_q(z)}{\left(1 + C_q(z) [FG_oG_{h0}]_q(z)\right)}$$

Also, the staircase approximation to the sampled output is given by

$$\hat{Y}_f(s) = G_{h0}(s)Y_{fq}(e^{s\Delta})$$

# Comparison of Continuous Response with *Stair-Case* Version

---

The ratio of the continuous time output response to the staircase form of the sampled output response is given by

$$\frac{Y_f(s)}{\hat{Y}_f(s)} = \frac{F(s)G_o(s)}{[FG_oG_{h0}]_q(e^{s\Delta})}$$

For simplicity, in the sequel, we will ignore the anti-aliasing filter  $F(s)$ .

---

---

From the above expression one then immediately sees that the ratio of the continuous time output response to the staircase form of the sampled output response depends on the ratio

$$\Theta(s) = \frac{G_o(s)}{[G_o G_{h0}]_q (e^{s\Delta})}$$

This expression gives us a way of predicting the nature of the continuous time response based on the discrete time response.

We illustrate below by reconsidering the servo example. We recall this example below.

# Example 13.5

---

We recall the servo system of Chapter 13. The continuous time transfer function for this system is given by

$$G_o(s) = \frac{1}{s(s+1)}$$

In Chapter 13, we synthesized a minimal prototype controller with sampling period  $\Delta = 0.1[s]$ . The results were

$$G_{oq}(z) = 0.0048 \frac{z + 0.967}{(z - 1)(z - 0.905)}$$

$$C_q(z) = 208.33 \frac{z - 0.905}{z + 0.967}$$

$$T_{0q}(z) = \frac{1}{z}$$

We also recall that the sampled and continuous output responses were as shown on the next slide.

Figure 13.6: *Plant output for a unit step reference and a minimal prototype digital control. Plant with integration.*

---

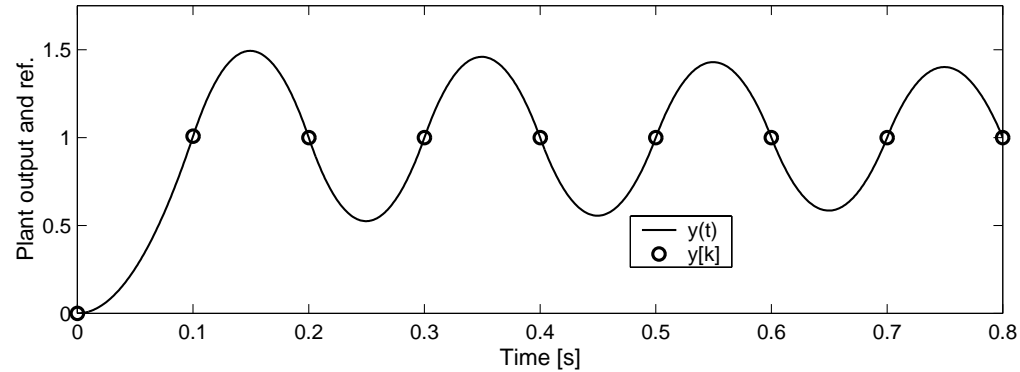

---

Note that the above results are essentially identical to the simulation results presented for the motivational example given earlier.

# Example 14.1

---

The magnitude of the ratio  $\Theta(j\omega)$  for the above design is shown in Figure 14.4 on the next slide. We see from this figure that the ratio is 1 at low frequencies but at  $\omega = \frac{\pi}{\Delta} [rad/s]$  there is a ratio of, approximately 23:1 between the frequency content of the continuous time response and that of the staircase form of the sampled output. This explains the very substantial intersample response associated with this example.



Figure 14.4: *Frequency response of  $\Theta(j\omega)$ ,  $\Delta = 0.1$*

---

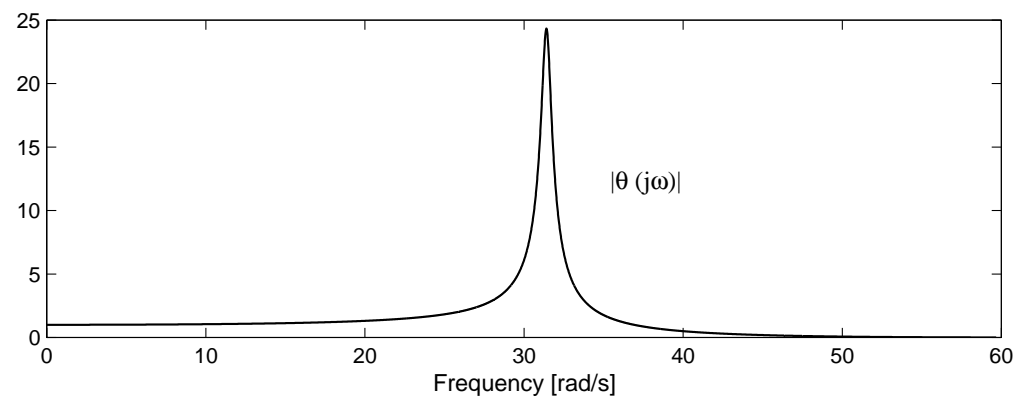

# Discussion of the Results

---

We recall that this design canceled the sampling zero and led to  $T_{0q}(z) = z^{-1}$  which is an all-pass transfer function. Hence a sampled sine wave input in the reference leads to a sampled sine wave output of the same magnitude. However, Figure 14.4 predicts that the corresponding continuous output will have 23 times more amplitude for a sinusoidal frequency  $\omega = \frac{\pi}{\Delta} [rad/s]$ . The reason for this peak is easily seen. In particular, the minimal prototype cancels the sampling zero in the discrete system. However, this sampling zero is near  $\omega = \frac{\pi}{\Delta} [rad/s]$ . Hence, it follows that the continuous time output must have significant energy at  $\omega = \frac{\pi}{\Delta} [rad/s]$ .

---

We see that the basic cause of the intersample problem in the above example is that  $T(e^{j\omega\Delta})$  is all-pass. Hence, the discrete frequency response has magnitude 1 at all frequencies. However, inspection of Figure 14.4 indicates that, for this example, there will be substantial magnification of the *continuous response* in the vicinity of the folding frequency.

The remedy would appear to be to use a design in which  $|T(e^{j\omega\Delta})|$  is reduced near the folding frequency. This observation is confirmed below.

---

We repeat the servo design example but instead of the Minimal Prototype Controller (which cancelled the sampling zeros in the discrete model), we will use the Minimum Time Dead Beat Controller. We recall from Chapter 13, that this control law does not cancel the sampling zeros but instead leads to the following closed loop transfer function

$$T(z) = \frac{\alpha B_0(z)}{z^n}$$

# Minimum Time Dead-beat Design

---

Thus, for the servo system, the minimum time dead-beat design leads to the following discrete time complementary sensitivity function:

$$T_{oq}(z) = \frac{B_{oq}(z)}{B_{oq}(1)z^2} = \frac{0.5083z + 0.4917}{z^2}$$

The magnitude of the frequency response of this complementary sensitivity is shown in Figure 14.5 on the next slide.

# Figure 14.5 *Frequency response of the complementary sensitivity for a minimum time dead-beat design*

---

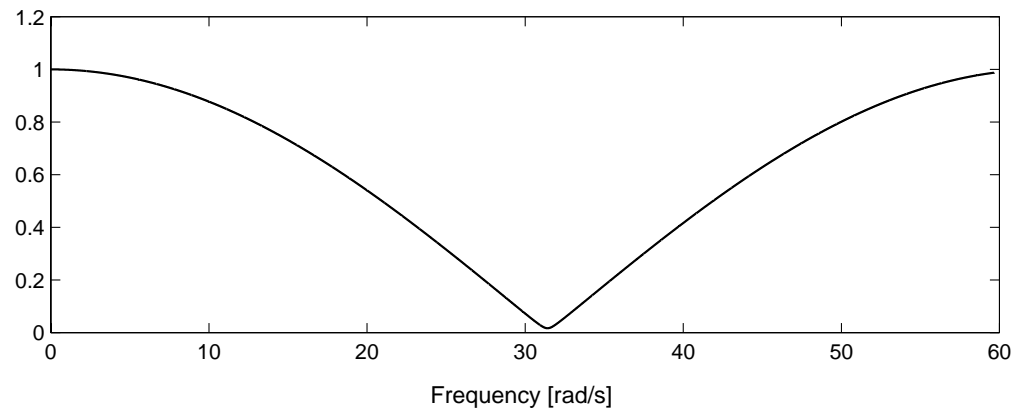

---

We see that, in this case, the discrete time gain drops dramatically at  $\omega = \frac{\pi}{\Delta} [\text{rad}/s]$  and hence, although Figure 14.4 still applies with respect to  $\Theta(j\omega)$ , there is now little discrete time response at  $\frac{\pi}{\Delta} [\text{rad}/s]$  to yield significant intersample ripple.

We observe that this design makes no attempt to compensate for the sampling zero, and hence there are no unpleasant differences between the sampled response and the full continuous time response.

This is borne out in the simulated response which is repeated below from Chapter 13.

Figure 13.7: *Minimum time dead-beat control for a second order plant*

---

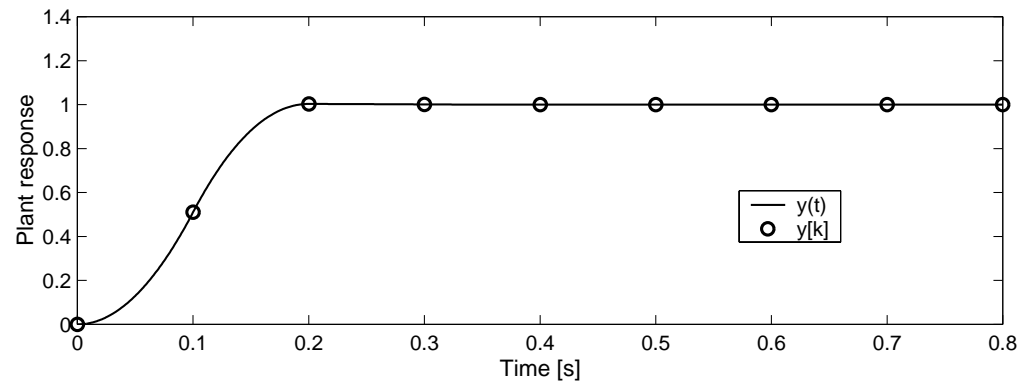



# Summary

---

- ❖ Hybrid analysis allows one to mix continuous and discrete time systems properly.
- ❖ Hybrid analysis should always be utilized when design specifications are particularly stringent and one is trying to push the limits of the fundamentally achievable.
- ❖ The ratio of the magnitude of the continuous time frequency content at frequency  $\omega$  to frequency content of the staircase form of the sampled output is

$$\Theta(s) = \frac{G_0(s)}{[G_0 G_{h0}]_q(e^{s\Delta})}$$

- 
- ❖ The above formula allows one to explain apparent differences between the sampled and continuous response of a digital control system.
  - ❖ Sampling zeros typically cause  $[G_0 G_{h0}]_q (e^{j\omega\Delta})$  to fall in the vicinity of  $\omega = \frac{\pi}{\Delta}$ , i.e.  $|\Theta(j\omega)|$  increases at these frequencies.
  - ❖ It is therefore usually necessary to ensure that the discrete complementary sensitivity has been reduced significantly below 1 by the time the folding frequency,  $\frac{\pi}{\Delta}$ , is reached.

- 
- ❖ This is often interpreted by saying that the closed loop bandwidth should be 20% or less, of the folding frequency.
  - ❖ In particular, it is never a good idea to carry out a discrete design which either implicitly or explicitly cancels sampling zeros since this will inevitably lead to significant intersample ripple.